INSTRUCTIONS IMPORTANT SAFEGUARDS

When using electrical equipment, basic safety precautions should always be followed including the following:

1. **READ AND FOLLOW ALL SAFETY INSTRUCTIONS**
2. Disconnect power before performing work on electrical equipment.
3. Do not let power cords touch hot surfaces and do not mount near gas or electric heaters.
4. Use caution when servicing batteries. Battery acid can cause burns to skin and eyes. If acid is spilled on skin or eyes, flush with fresh water and contact a physician immediately.
5. Equipment should be mounted in locations and at heights where unauthorized personnel will not readily subject it to tampering.
6. The use of accessory equipment not recommended by Beghelli may cause an unsafe condition, and will void the unit's warranty.
7. Do not use this equipment for other than its intended purpose.
8. Servicing of this equipment should be performed by qualified service personnel.
9. **SAVE THESE INSTRUCTIONS!**

STRAP MOUNTING

1. Extend unswitched 24 hour AC supply of rated voltage installed in accordance with all applicable codes and standards. Leave at least 8 inches of slack wire. This circuit should NOT be energized/live at this time.
2. Knock out $\frac{7}{8}$ " power entry hole on top of unit.
3. Mount the unit securely into place. Install four (4) screws. Fasten each strap with an appropriately sized screw or mounting bolt (not supplied) through each hole and into the mounting surface/wall. Each fastener must be securely in place to properly support the unit (Figure 1).
4. Open the unit by unscrewing the two (2) lens screws and (2) cover screws. Let cover assembly hang on tether (Figure 2) (Figure 3).
5. Install conduit bushing (Figure 6).
6. Make proper wiring connections between the AC supply and the unit's transformer per diagram provided (Figure 4). **Insulate unused wire seperately!** Connect ground to supplied green ground wire in accordance with local codes. Reassemble all wire connections and connectors. **CAUTION! - Failure to insulate unused wire may result in a shock hazard or unsafe condition as well as equipment failure. All wires must be dressed and routed to ensure they will not come in contact with the circuit board.**
7. Connect the wire lead(s) from the positive circuit board terminal (+) to the positive terminal connector on the battery (Figure 3). For large units the batteries may be shipped separate from the cabinet. Install the batteries into the cabinet and make the appropriate inter-battery connections (Figure 5).
8. Close cover and secure cover screws.
9. Position lamps/heads to provide best lighting distribution. Manually rotate or twist head to desired position.
10. Close lens and secure with (2) screws.
11. Turn on AC line voltage supply.

JUNCTION BOX MOUNTING

1. See 1 and 4 above.
2. Knock out appropriate mounting hole in back of base (Figure 7).
3. Install gasket over mounting holes (Figure 7).
4. Mount base to junction box.
5. See 6 –11 above.

MAGNETIC TEST

1. To test, pass a magnet over test marking to initiate the test (Figure 1). Charge indicator will go out and the DC lamps will come on.

TEST BUTTON

1. Open unit by unscrewing (2) lens screws and press test button.

A bright charge indicator indicates a high charge rate. After the battery has reached full charge, the indicator light will go out. Under normal operation the high charge indicator will turn off and on intermittently while the unit is in standby mode (regular/mains AC present) since the charge rate will vary in order to maintain an optimal battery charge.

OPERATION

Figure 1

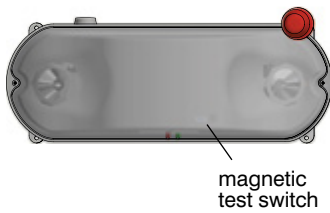

Figure 3

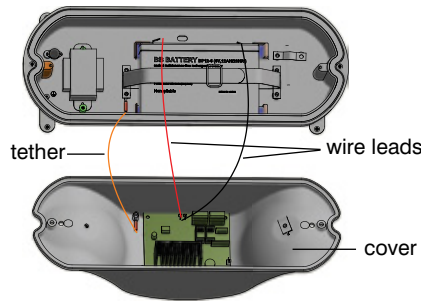

Figure 5

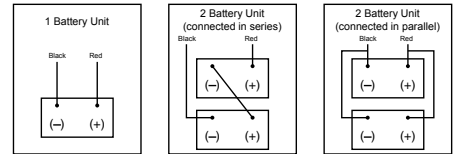

Figure 2

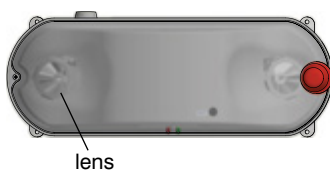

Figure 4 CHARGER BOARD TRIPLE INPUT VERSION

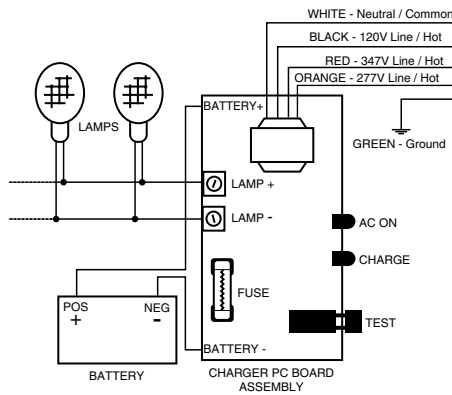

Figure 6

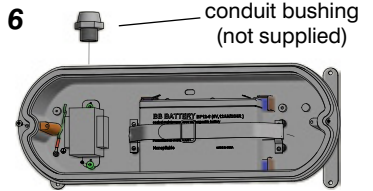
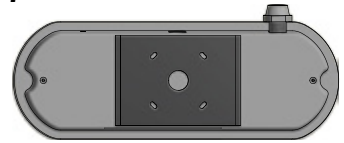

Figure 7



MAINTENANCE

1. Beghelli strongly recommended compliance with all Code requirements.
2. Clean lenses on a regular basis.

NOTE: The servicing of any parts should be performed by qualified service personnel only. The use of replacement parts not furnished by Beghelli may cause equipment failure and will void the warranty.

TROUBLESHOOTING

IMPORTANT NOTE: If the Time Delay optional feature is installed, emergency lamps will remain lit for up to 10 minutes following the resumption of regular/mains AC power to the unit.

EMERGENCY LAMPS DO NOT COME ON AT ALL, "AC ON" LED indicator is out before test...

Pilot Light is out before test...

1. Check AC supply - be sure unit has 24 hour AC supply (unswitched).
2. AC supply is OK, and indicator light is out, replace PC Board Assembly.

Pilot Light is on before test

1. Either the output is shorted or overloaded, or the battery is not connected.
2. Battery is severely discharged. Allow 24 hours for recharge and then retest. NOTE: This could be the result of a switched AC supply to the unit (which has been turned off at some point), a battery with a shorted cell, an old battery or a battery which has been discharged due to a long power outage and is not yet fully recharged.

EMERGENCY LAMPS COME ON DIM WHEN TEST SWITCH IS ACTIVATED

1. Battery discharged - permit unit to charge for 24 hours and then retest. If lamps are still dim, check charger for proper function. If charger functions correctly, replace battery.

EMERGENCY LAMPS COME ON WHEN BATTERY IS FIRST CONNECTED

1. Battery may be connected in reverse polarity. Check connections. Connect Positive lead to Positive battery terminal and Negative lead to Negative battery terminal. The lamps should then turn off and the charge indicator should light when AC power is applied.

EMERGENCY LAMPS COME ON DIM WHEN AC POWER IS ON -

1. Check supply voltage and AC connections. This emergency light is provided with brownout protection. The AC supply must be at least 80% of nominal (96V on a 120V line) for equipment to function normally. At lower voltages the emergency lamps will begin to glow dimly until the source voltage drops below the full "turn-on" point. NOTE: This condition may also be caused by incorrectly connecting a 120 Volt supply line to the wrong voltage transformer lead.

SAVE THESE INSTRUCTIONS