

INSTALLATION INSTRUCTIONS

IMPORTANT SAFEGUARDS

Read & Follow All Safety Instructions

When using electrical equipment, basic safety precautions should always be followed including:

1. Disconnect power before performing work on electrical equipment.
2. Do not use outdoors.
3. Do not mount near gas or electric heaters.
4. Do not let power cords touch hot surface.
5. Equipment should be mounted in locations and at heights where it will not be subjected to tampering.
6. The use of accessory equipment not recommended by Beghelli Inc., may cause an unsafe condition, and will void the unit's warranty.
7. Do not use this equipment for other than its intended purpose.
8. Servicing of this equipment should be performed by a qualified service personnel.
9. DO NOT install in unstable, loose or breakable surfaces.
10. DO NOT let objects impact or exert force on the surface of the fixture.

WARNING: FAILURE TO FOLLOW THESE INSTRUCTIONS AND WARNINGS MAY RESULT IN DEATH, SERIOUS INJURY OR SIGNIFICANT PROPERTY DAMAGE - For your protection, read and follow these warnings and instructions carefully before installing or maintaining this equipment. These instructions do not attempt to cover all installation and maintenance situations.

WARNING: RISK OF ELECTRIC SHOCK - never connect to, disconnect from, or service while equipment is energized.

WARNING: RISK OF FIRE - Keep combustible material away from hot parts. Observe lamp manufacturer's warnings, recommendations, and restrictions on lamp operation and maintenance. Make sure lamps are correctly installed.

WARNING: DO NOT USE ABRASIVE MATERIALS OR OTHER SOLVENTS. USE OF THESE SUBSTANCES MAY DAMAGE FIXTURE, WHICH MAY RESULT IN PERSONAL INJURY.

WARNING: RISK OF PERSONAL INJURY - This product may have sharp edges. Wear gloves to prevent cuts or abrasions when removing from carton, handling, installing and maintaining this product.

SAVE THESE INSTRUCTIONS!

INSPECTION AND MAINTENANCE

NOTE: On emergency (EL) models, the battery may be supplied with less than a full charge. After continuous AC power is provided, allow 24 hours for full charge and before initial testing.

LAMP OR BATTERY REPLACEMENT: Use only the replacement part specified on the product (UL) label. Use of any other light source or battery may result in transformer damage or unsafe conditions.

INSTALLATION (TOP MOUNT)

1. See Fig 1 (right) before beginning installation.
2. Position metal housing and bar hangers between ceiling or wall joists. Make sure bar hangers are in the correct position to be mounted. Position metal housing temporarily by hammering nail-in tabs on bar hangers, then secure permanently with nails or screw. Bar hangers should be level with bottom of joists (Fig. 2).
3. Adjust height of metal housing so that the bottom of the housing is just above the ceiling or wall (Fig. 3).
4. Reference correct wiring diagram and make proper electrical connections at the J-box in the metal housing (Fig. 4 & 5).

CAUTION: The unused lead must be insulated with the remaining provided wire nut or other approved method.
5. Determine directional Chevron requirements. Follow instructions on provided templates to apply the required Chevron(s). See also Fig. 6.
6. Attach safety chain to holes in trim plate assembly. Snap together the quick-connector harness to connect the LED board to the transformer.
7. Connect the battery (EL models) after continuous AC power can be provided to the unit.
8. Secure the trim plate assembly using the provided screws.

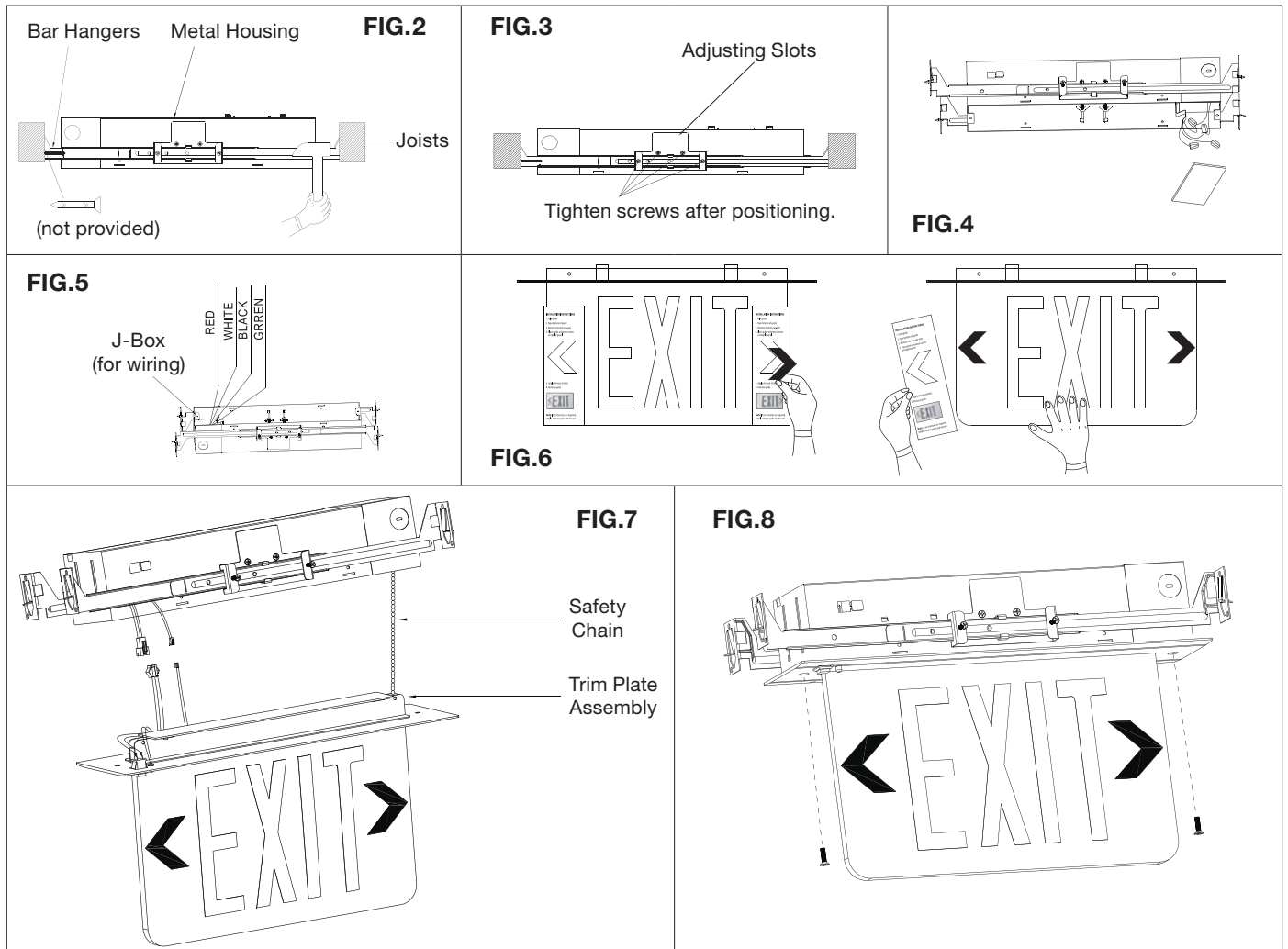
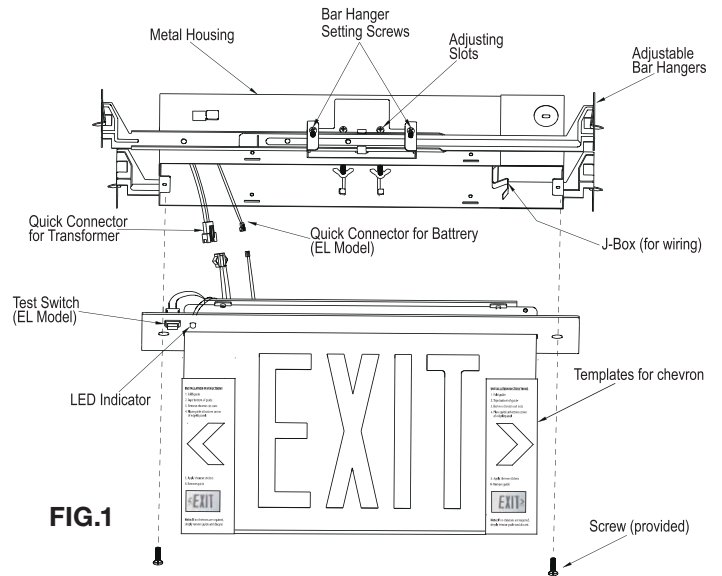

INSTALLATION (BRACKET MOUNT)

NOTE: The unit comes with hardware (placed in a separate pouch) for drywall remodel installation. The pouch should contain a set of (4) metal brackets, (4) small screws, (4) nuts, (4) long screws, and (4) screw holders.

1. Remove all mounting hanger bars.
2. Slide the screw holders into the holes on the unit's housing as shown in Fig. A.
3. Secure the screw holders with the small screws provided (refer to Fig. B and C).
4. Position the metal brackets beneath the screw holders and inset the long screws (refer to Fig. D). Tighten the screw until the head reaches the screw holder (refer to Fig. E).

CAUTION: DO NOT TIGHTEN THE SCREWS TO THE POINT WHERE THE BRACKETS START TO EXPAND OUTWARD.

5. Cut a hole in the ceiling or wall using the provided template. Turn housing on the side and slide through the hole in the ceiling or wall.
6. Once the housing is inside the ceiling or wall, return back to original position and start tightening the long screws. At this point the brackets start to bow out. (Fig. F).
7. Follow steps 4-8 from page 2 to finish.

INSTALLATION (RECESSED BOX SIDE HANGER BAR-MOUNTING)

1. Knock-out the slot at the end of recessed box. (refer to Fig. H).
2. Un-tight the Wing Nut and remove both of the Hanger Bars and washers. (refer to Fig. I).
3. Install the Hang Bar to the side of the recessed box and tight up the Wing Nut with the washer. (refer to Fig. J).
4. Follow steps 1-8 from the Top Mount Instructions (page 2).

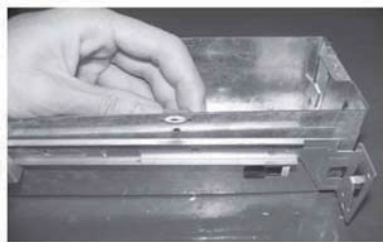

FIG.A



FIG.B

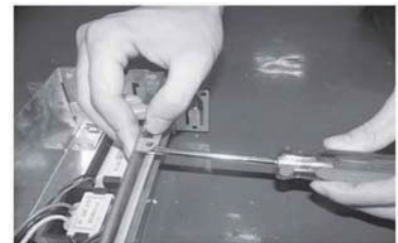

FIG.C



FIG.D



FIG.E



FIG.F



FIG.G



FIG.H



FIG.I

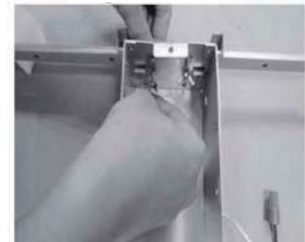
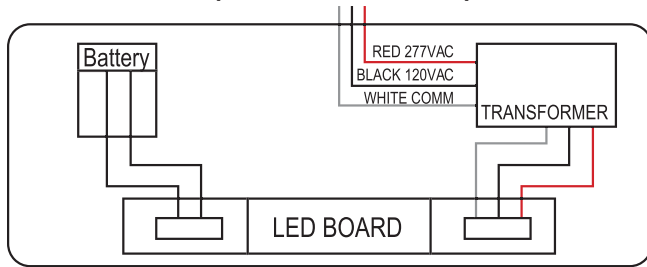

FIG.J

WIRING DIAGRAMS

NOTE: Unused input lead must be properly insulated with wire nut or other approved method.

120/277 VOLT (BATTERY BACKUP)



120/277 VOLT (AC ONLY)

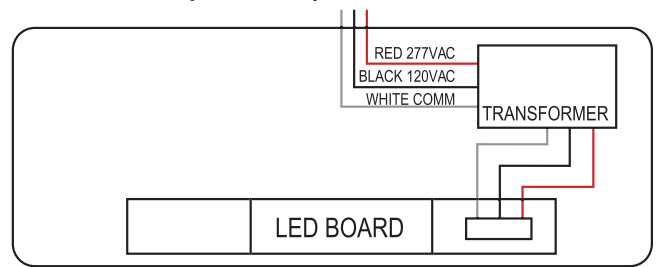

120/277 VOLT (SELF DIAGNOSTIC)

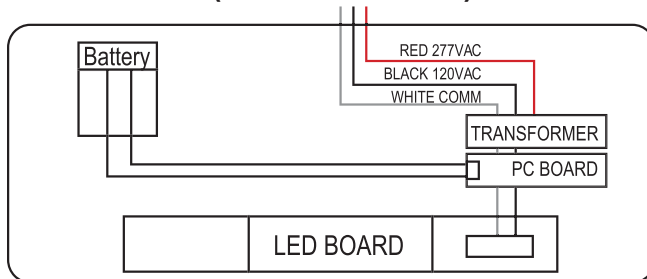

208/220/240 VOLT (BATTERY BACKUP)

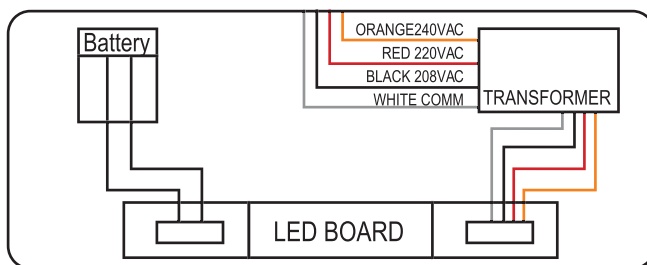

208/220/240 VOLT (AC ONLY)

