

WG SERIES

WIREGUARDS

Job/Location: _____



Contractor: _____

Prepared By: _____

Job Type: _____

Date: _____

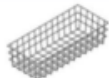
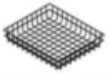
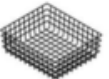
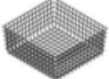
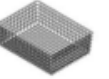
MODELS

ITEM	MODEL	DESCRIPTION
300400008-001	 WG-4.5DX17.5LX7W-WHT	WIREGUARD, 4.5"D X 17.5"L X 7"W, WHITE (TEMPESTA)
300400012-001	 WG-3DX16.5LX14W-WHT	WIREGUARD, 3"D X 16.5"L X 14"W, WHITE (ESM-6V18-50W, FME, FME-C, FTZ-PLUS, OL2, OL2-CT, QR-PL, STX, STX-C, NYC-STX)
300400013-001	 WG-6DX16.5LX14W-WHT	WIREGUARD, 6"D X 16.5"L X 14"W, WHITE (CRV, ESL, NYC-ESM, ESM-6V72-90W, EST, EVR, FTZ, FTZ-BU, FTZ-C, OL2, VE)
300400009-001	 WG-9DX20LX19W-WHT	WIREGUARD, 9"D X 20"L X 19"W, WHITE (ROBUSTO, WLX COMBO, VESTA375)
300400010-001	 WG-9DX26LX19W-WHT	WIREGUARD, 9"D X 26"L X 19"W, WHITE (ESM-24V-360-720W, VESTA600)
300100130-001	 WG-1.2DX 45LX4.9W-WHT-FIXMNT	WIREGUARD, 1.2"D X 45"L X 4.9"W, WHITE (ACCIAIO BX910LED 4 FOOT, FIXTURE MOUNTING)
300100058-000	 WG-.7DX48LX12W-GRY-FIXMNT	WIREGUARD, 0.7"D X 48"L X 12"W, GREY (ACCIAIO BX940LED 4 FOOT, FIXTURE MOUNTING)

NOTE:

- Surface mount wire guards include 4 metal P-clips for secure mounting
- Sturdy metal wire construction
- Powder coat paint finish

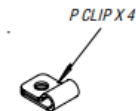

WG SERIES

(WIREGUARDS)

DIMENSIONS

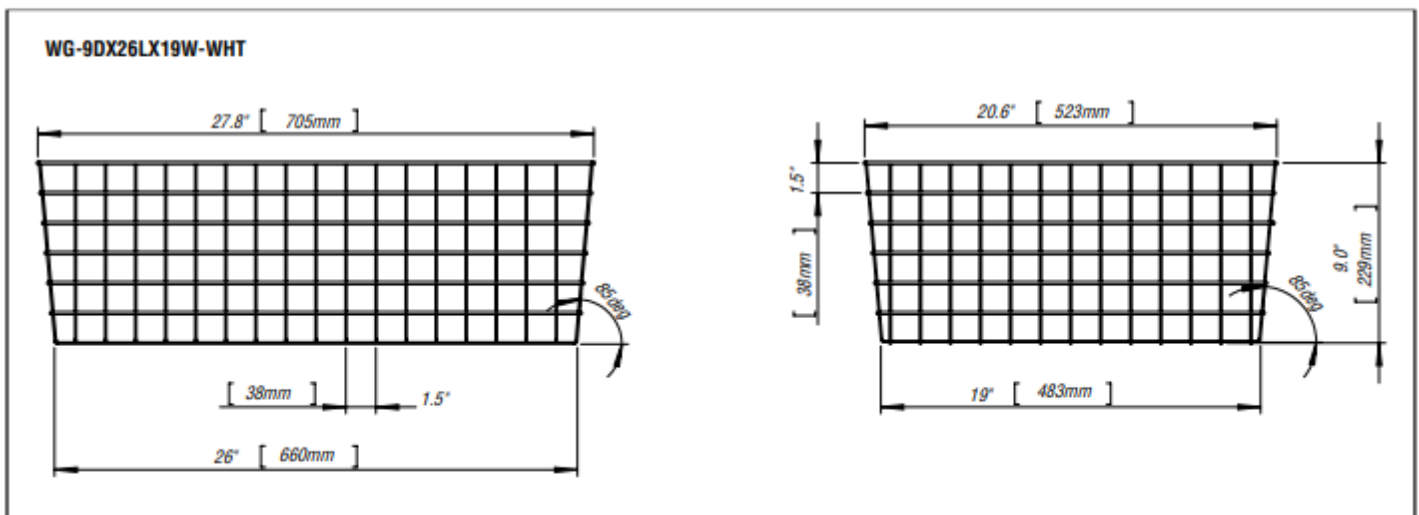
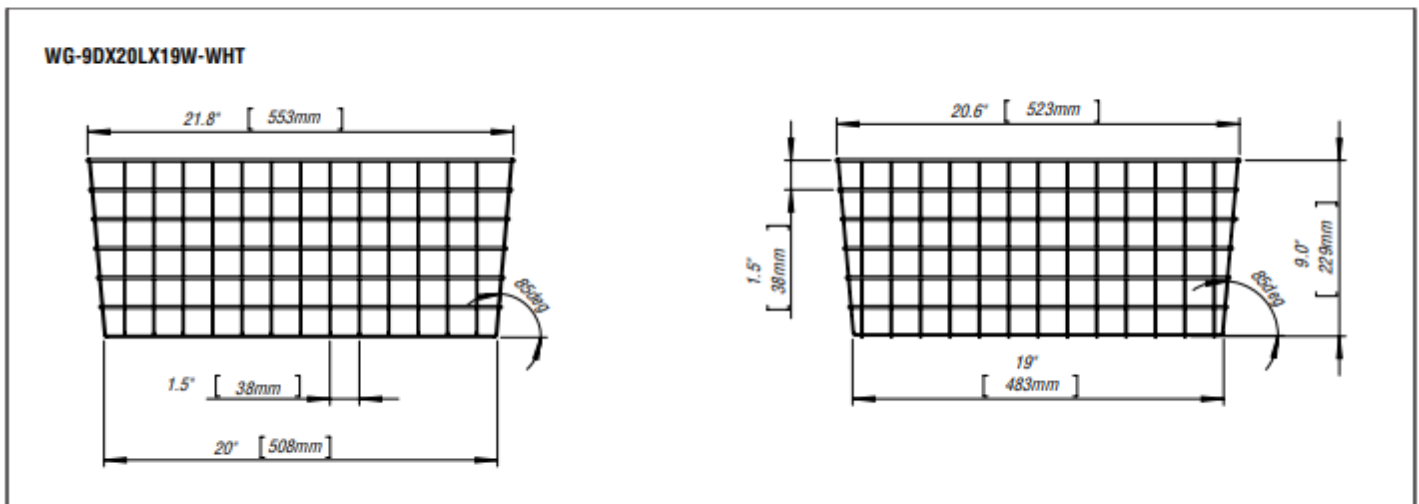
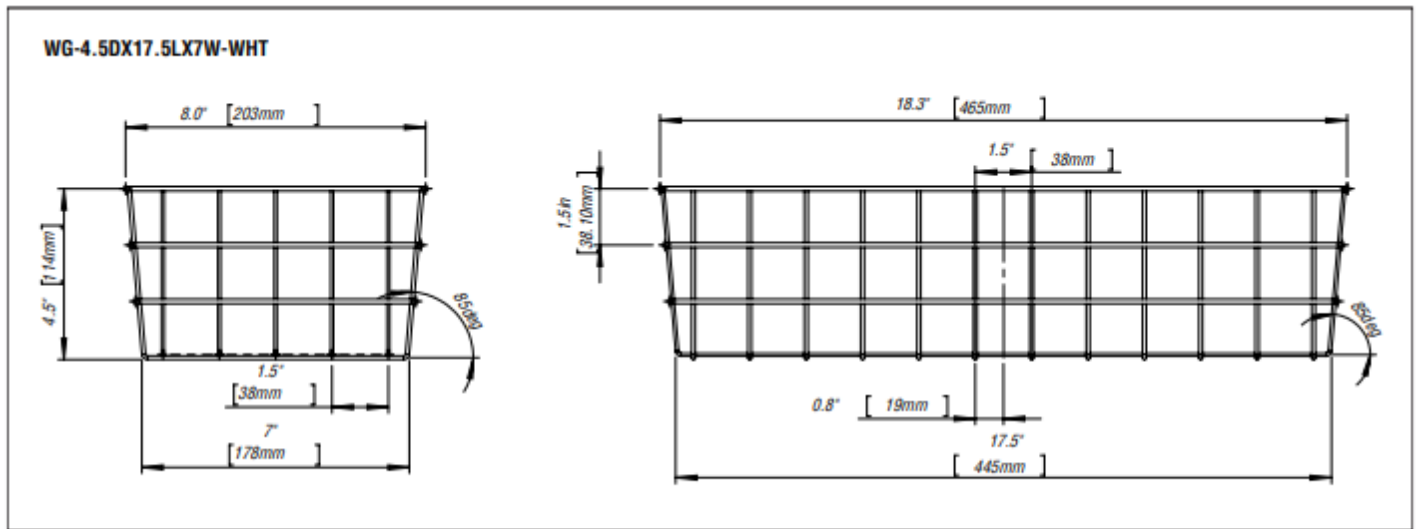

WG SERIES

(WIREGUARDS)

DIMENSIONS

WG-3DX16.5LX14W-WHT

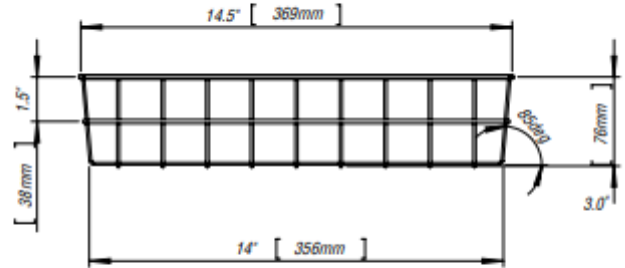
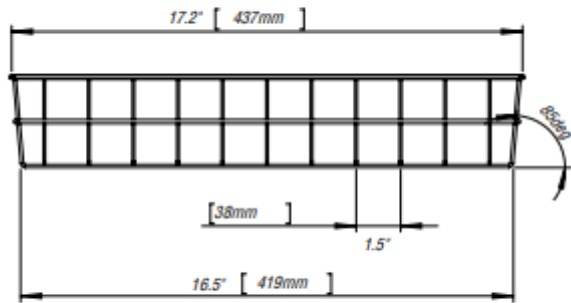

WG-6DX16.5LX14W-WHT

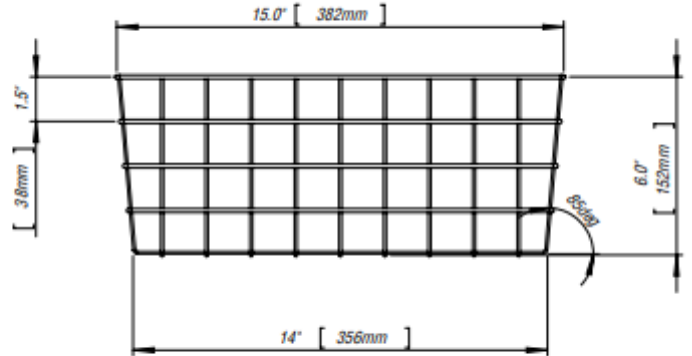
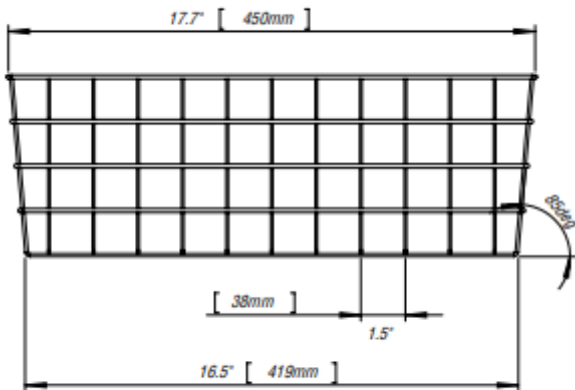

WG SERIES

(WIREGUARDS)

DIMENSIONS

WG-1.2DX45LX4.9W-WHT-FIXMNT

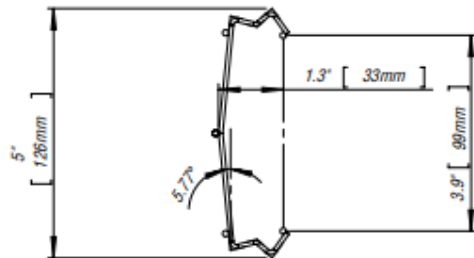
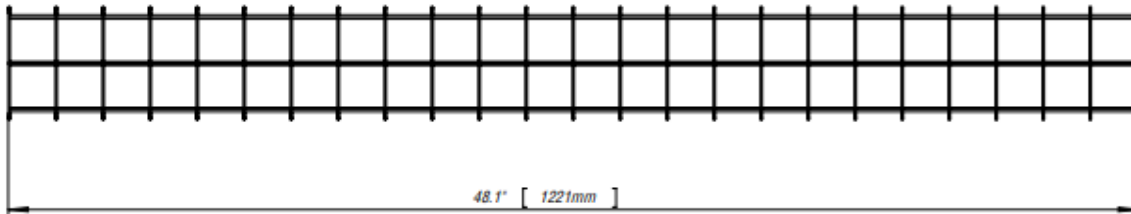

Note:
Snap-fits onto face of Acciaio fixture
(no tools or hardware required)

WG-.7DX48LX12W-GRY-FIXMNT

