

**IMPORTANT SAFEGUARDS**

When using electrical equipment, basic safety precautions should always be followed including:

**READ AND FOLLOW ALL SAFETY INSTRUCTIONS.**

- CAUTION! ALWAYS MAKE SURE THE POWER IS TURNED OFF** before starting installation.
- Measure, locate fixture's position, and mark locations for the brackets.
- Secure brackets to ceiling as shown below. **(HARDWARE BY OTHERS)**
- Wiring fixture to power supply, shall be performed by a **certified electrician**, and wired in a manner that complies with all local and national electrical codes, as well as the **manufacturer's wiring diagram**.



**SAVE THESE INSTRUCTIONS!**

**CEILING SURFACE MOUNTING**

AFFIX MOUNTING TEMPLATE TO CEILING TO PROPERLY ALIGN FIXTURE. (REMOVE AFTER INSTALLATION)

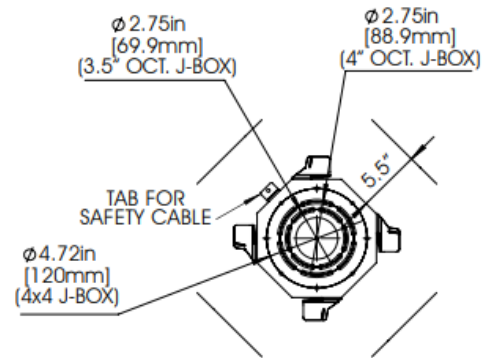
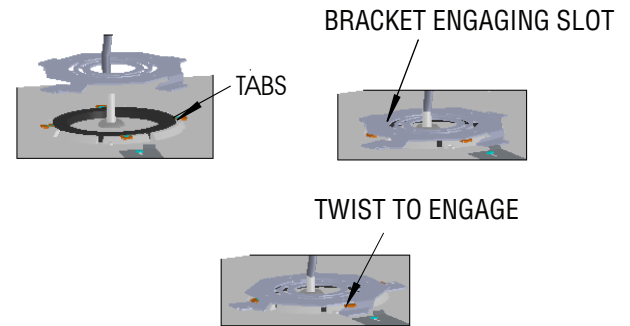
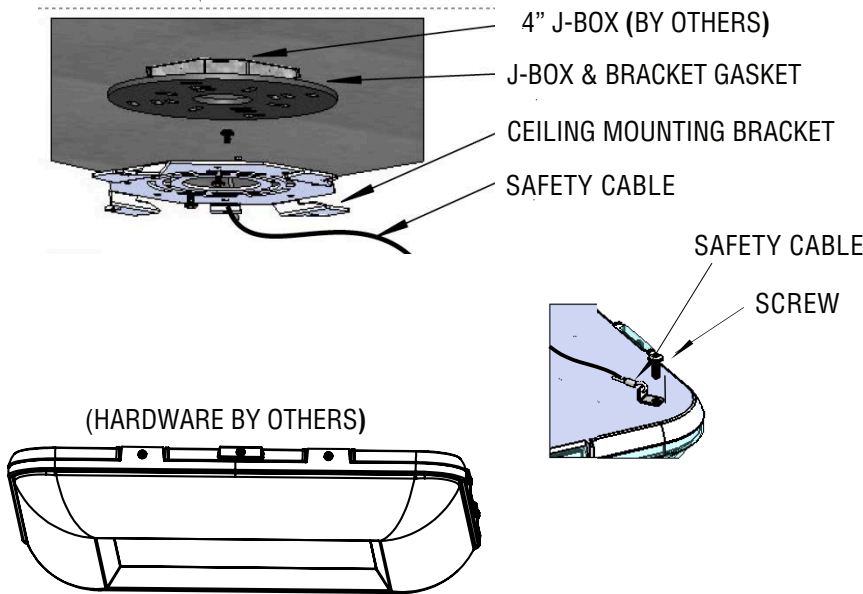

**WIRING DIAGRAM**

**0-10V LEAD / DALI**  
 VIOLET.....(DIM +)  
 GRAY.....(DIM -)

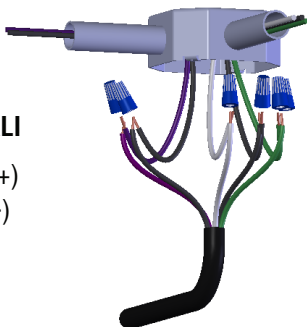

**AC LEADS**  
 BLACK..... (HOT)  
 WHITE.....(NEUTRAL)  
 GREEN..... (GROUND)

0-10V dimming wires must be run from a different conduit out of the j-box.

For ease of engaging the fixture to the mounting bracket, it is recommended to draw temporary lines parallel to the straight edges of the bracket (as shown above). Use those lines to line up your fixture before you twist and lock the fixture onto the bracket.

**AC - AVIATION CABLE KIT**

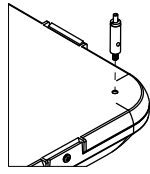
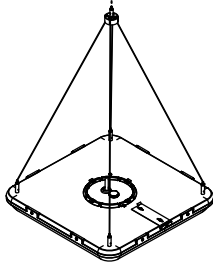

Fig 1

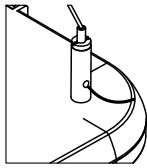

Fig 2

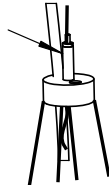
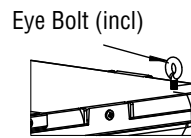
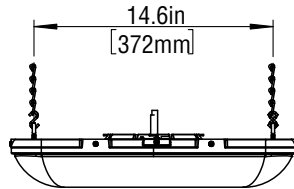
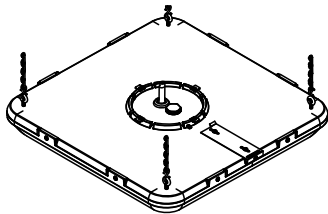

Fig 3

1. Install cable glider as shown in Fig 1
2. Feed the cable thru the cable glider (use cable gliders for leveling the fixture; Push top of sleeve of cable glider to release lock and adjust cable) - Fig 2
3. Adjust height of fixture using cable glider in Fig 3

**CH - CHAIN HANG KIT**



Eye Bolt (incl)



Chain



'S' hook

1. Install the eye bolts into the housing as shown.
2. Hook the chain and the eye bolt together using provided "S" hook
3. Close all "S" hooks

**PK - PENDANT KIT**

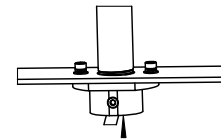
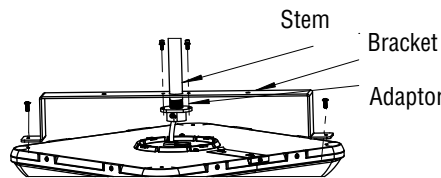
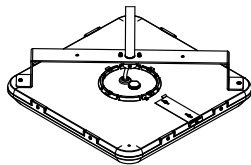

Feed the power cord thru stem

1. Attach the bracket to fixture as shown.
2. Attach stem adaptor to bracket.
3. Install stem thru bracket & to adaptor
4. Install screw to secure the stem

**TM - TRUNION MOUNT**

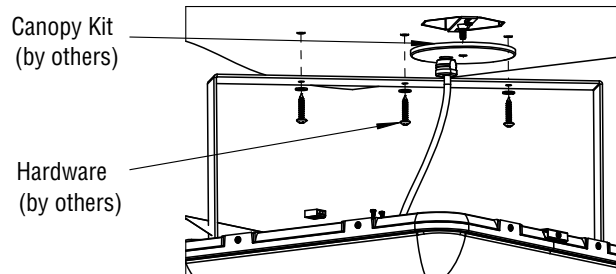
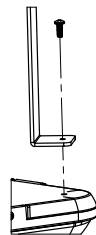
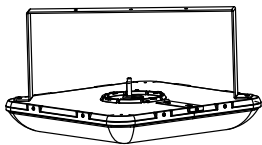

Canopy Kit (by others)

Hardware (by others)

1. Attach the bracket to fixture as shown.
2. Attach the assembly to ceiling as shown (hardware and canopy kit by others)